







## Bianca Smart Sensor Pull Out Kitchen Mixer

### Finish & SKU

 <b>Chrome</b> NR321508aCH	 <b>Brushed Nickel</b> NR321508aBN
 <b>Matte Black</b> NR321508aMB	 <b>Brushed Gold</b> NR321508aBG
 <b>Brushed Bronze</b> NR321508aBZ	 <b>Gun Metal</b> NR321508aGM



### Specifications

#### Watermark License

WM-060073

#### Temperature Rating

Min 1°C-Max 75°C

#### Pressure Rating

Min 150kpa-Max 500kpa

### Warranty



### Features

- Smart Sensor & Manual Control – Use touch-free sensor or traditional handle without interference.
- Pull-Out Function – Flexible spray for easy rinsing and cleaning.
- Low Lead DZR Brass – Durable, corrosion-resistant, and safe for drinking water.
- Rust-Resistant Braided Hose – Polyamide Braided PEX Hose ensures durability and prevents rust.
- Standard Battery-Powered – Ready to use with batteries included.
- Optional Power Adapter – Available for purchase separately for direct plug-in use.

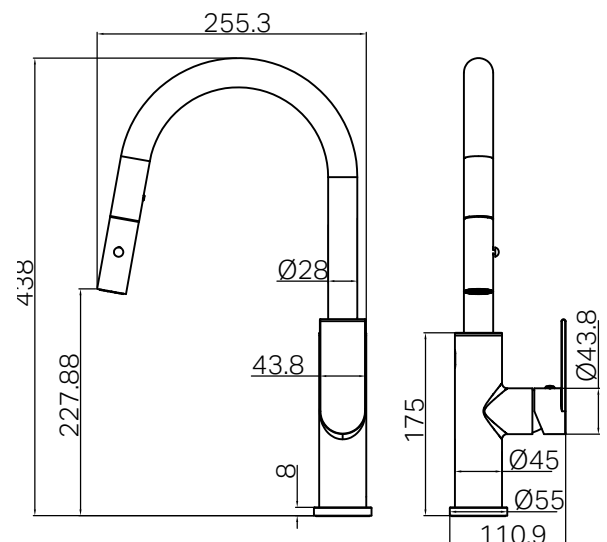

### Maintenance And Care

- Regularly check the mixer and connections for signs of wear or leaks.
- Clean the tap with mild soapy water to maintain its appearance, avoiding harsh chemicals and abrasive materials that may damage the finish.

- Dimensions are nominal measurements only.